

Input: Thermocouples J, K, T, E, R, S, N, B, C, D, G, M, P
Output: 0-1 V to 0-10 V, ±1 V to ±10 V, 0-1 mA to 25 mA, 4-20 mA

- Convert Temperature to DC Output
- Zero and Span Output Calibration Potentiometers
- Automatic Temperature Compensation
- Input and Output LoopTracker® LEDs
- Output Test Button
- Built-In Loop Power Supply for Output

Applications

- Convert Output From Thermocouple Sensor for PLC Input, Control and/or Validation
- Interface an Thermocouple with Panel Meters, PLCs, Recorders, Data Acq., DCS, & SCADA Systems

Thermocouple Input Types, Factory Set

Specify thermocouple type and temperature range in °F or °C

J, K, T, E, R, S, N, B, C, D, G, M, P

Full ANSI temperature ranges

Linearization: 41-55 segment or up to 14th order polynomial

Cold Junction Compensation

Automatic for specified thermocouple

T/C Burnout Protection

Upscale burnout protection standard

B option: Downscale burnout protection

NB option: None

T/C Current

Less than 10 µA, including burnout sense

LoopTracker

Variable brightness LEDs indicate I/O loop level and status

Status LED

Yellow LED indicates I/O errors

DC Output Range

Factory ranged: specify output type and range

Voltage: 0-1 VDC to 0-10 VDC, 10 mA max

Bipolar voltage: ±1 VDC to ±10 VDC

Current: 0-1 mADC to 0-25 mADC, 4-20 mADC
 20 V compliance, 1000 Ω at 20 mA

Calibration

Multi-turn zero and span potentiometers for output
 ±15% of span adjustment range typical

Output Loop Power Supply

20 VDC nominal, regulated, 25 mADC, max. ripple <10 mVrms

EXTSUP option: Unpowered mA output

Output Test

Sets output to test level when pressed
 Test level factory set to approx. 50% of span
 Call factory for custom setting

Output Ripple and Noise

Less than 10 mVrms

Accuracy

±0.25% of span typical, 16-bit analog output

HA option: ±0.1% of span typical, 18-bit analog output

Ambient Temperature Range and Stability

-10°C to +60°C operating ambient
 Better than ±0.04% of span per °C stability

Response Time

300 milliseconds typical

Isolation

2000 Vrms minimum

Full isolation: power to input, power to output, input to output

Installation Environment

IP 40, requires installation in panel or enclosure
 Use with API 008 or API 008 FS socket
 Socket mounts to 35 mm DIN rail or can be surface mounted
 UL 508C pollution degree 2 environments or better

Power

Standard: 115 VAC ±10%, 50/60 Hz, 2.5 W max.

A230 option: 230 VAC ±10%, 50/60 Hz, 2.5 W max.

P option: 85-265 VAC 50/60 Hz, 60-300 VDC 2.5 W typ.

D option: 9-30 VDC, 2.5 W typical

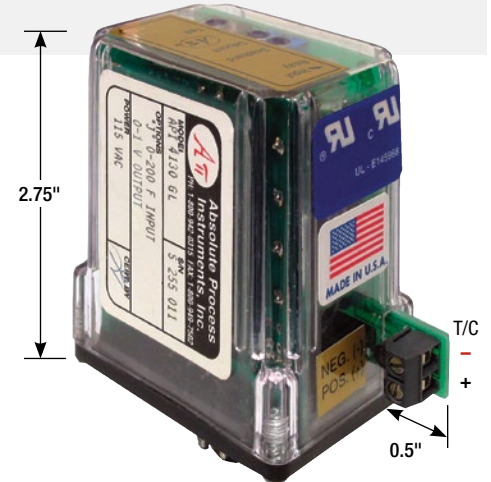
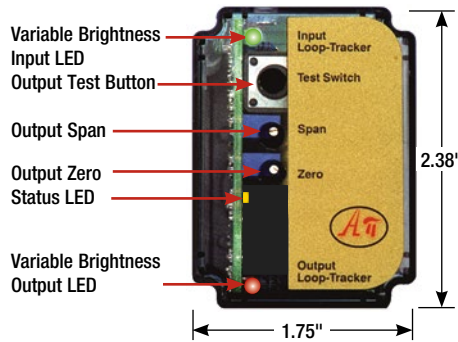

**High Accuracy
 16- or 18-Bit
 Microprocessor-
 Based Linearization**



**Free Factory
 I/O Setup!**

**Quick Link
api-usa.com/4130**

Hot Swappable

API
 E145968
 115 VAC, 230 VAC
 powered models

Description

The API 4130 G L accepts a thermocouple input and provides an optically isolated and linearized DC voltage or current output. The thermocouple type, temperature span (°C or °F), and DC voltage or current output are factory configured.

Automatic cold-junction compensation and upscale burnout protection are standard, downscale burnout protection is optional.

The API 4130 G L features a thermocouple connection block on the side of the module. This allows direct temperature compensation at the T/C termination point eliminating cold junction errors.

The input is amplified, and then passed through an optocoupler to the output stage. Microprocessor-based linearization uses 41 to 55 segments or up to a 14th order polynomial depending on the sensor type. The low noise 16-bit (18-bit with HA option) analog output is isolated and can be set up for common voltage and milliamp output types.

Full 3-way isolation (input, output, power) make this module useful for ground loop elimination, common mode signal rejection, and noise pickup reduction.

Sink/Source Output Options

The API 4130 G L has a 20 VDC loop excitation supply for the output. This power supply can be used to power a passive mA device.

Order the API 4130 G L EXTSUP for an unpowered mA output for devices that are powered externally.

LoopTracker

API exclusive features include LoopTracker LEDs (green for input, red for output) that vary in intensity with changes in the process input and output signals.



They provide a quick visual picture of your process loop at all times and can greatly aid in saving time during initial startup and troubleshooting.

Output Test

An API exclusive feature includes an output test button to provide a fixed output (independent of the input) when held depressed. The output test greatly aids in saving time during initial startup and/or troubleshooting. The test output level is factory set at 50% of output span.

Mounting

The API 4130 G L plugs into an industry standard 8-pin octal socket sold separately. Sockets API 008 and finger-safe API 008 FS allow either DIN rail or panel mounting.

Model	Input	Output	Power
API 4130 G L	Factory configured Specify thermocouple type and temperature range in °F or °C	Factory configured specify output range in volts or mA	115 VAC 
API 4130 G L A230			230 VAC 
API 4130 G L P			85-265 VAC or 60-300 VDC
API 4130 G L D			9-30 VDC

Options—add to end of model number

- HA** High accuracy, ±0.1% span
- B** Downscale T/C burnout protection
- NB** No T/C burnout protection
- EXTSUP** Open collector output when a sinking output is required for an external loop supply
- U** Conformal coating for moisture resistance

Accessories—order as separate line item

- API 008** 8-pin socket
- API 008 FS** 8-pin finger-safe socket
- API CLP1** Module hold-down spring for high vibration or mobile applications



Precautions

WARNING! All wiring must be performed by a qualified electrician or instrumentation engineer. See diagram for terminal designations and wiring examples. Consult factory for assistance.
WARNING! Avoid shock hazards! Turn signal input, output, and power off before connecting or disconnecting wiring, or removing or installing module.

Précautions

ATTENTION! Tout le câblage doit être effectué par un électricien ou ingénieur en instrumentation qualifié. Voir le diagramme pour désignations des bornes et des exemples de câblage. Consulter l'usine pour assistance.

ATTENTION! Éviter les risques de choc! Fermez le signal d'entrée, le signal de sortie et l'alimentation électrique avant de connecter ou de déconnecter le câblage, ou de retirer ou d'installer le module.

API maintains a constant effort to upgrade and improve its products. Specifications are subject to change without notice. See api-usa.com for latest product information. Consult factory for your specific requirements.

WARNING: This product can expose you to chemicals including lead and nickel, which are known to the State of California to cause cancer or birth defects or other reproductive harm. For more information go to www.P65Warnings.ca.gov

Socket and Mounting

Install module in a protective panel or enclosure. Allow space around module for air flow. Use API 008 or API 008 FS socket. See specifications for maximum allowable socket voltages. The socket clips to a standard 35 mm DIN rail or can be mounted to a flat surface.

Electrical Connections

See model/serial number label for module power requirements, and any applicable options or custom ranges.

The sensor type and temperature range are factory configured. See the model/serial number label for module information, sensor type, temperature range and options.

Polarity must be observed for output wiring connections. If the output does not function, check wiring polarity.

Thermocouple Input Block

The thermocouple connection is made to the block on the side of the module. Polarity must be observed.

ANSI/ASTM thermocouples use red for negative. IEC thermocouples use white for negative. Other countries' standards may use other color coding.

Signal Output

Polarity must be observed when connecting the signal output to the load. The positive connection (+) is connected to terminal 7 and the negative (-) is connected to terminal 8.

Note that with a current output the module provides power to the output loop unless option EXTSUP was ordered for a sinking output requirement.

Module Power

Check model/serial number label for module operating voltage to make sure it matches available power.

AC power is connected to terminals 1 and 3.

For DC powered modules, polarity **MUST** be observed.

Positive (+) is wired to terminal 1

Negative (-) is wired to terminal 3

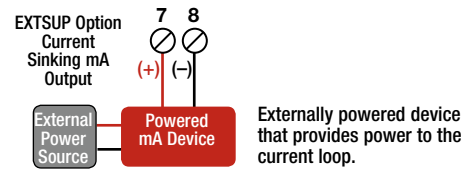
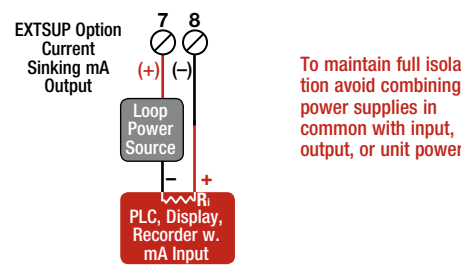
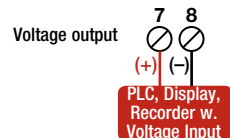
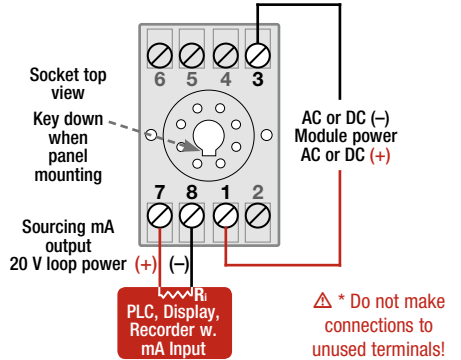
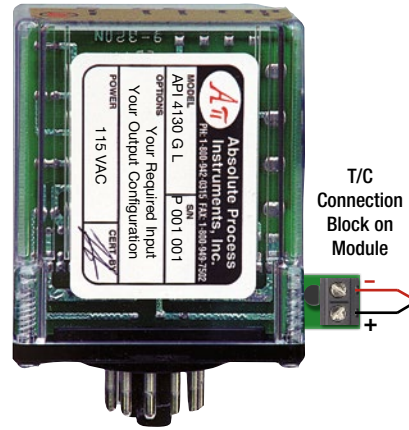

Calibration

Input and output ranges as specified on your order are factory pre-configured (at 24°C ±1°C).

Input and output ranges are listed on module labels. Input changes require factory modification.

Top-mounted Zero and Span potentiometers can be used to fine-tune the the output if necessary.

1. Apply power to the module and allow a minimum 20 minute warm up time.
2. Using an accurate temperature simulator, provide an input to the module equal to the minimum input required for the application.
3. Using an accurate measurement device for the output, adjust the Zero potentiometer for the exact minimum output desired. The Zero control should only be adjusted when the input signal is at its minimum. This will produce the corresponding minimum output signal. For example: 4 mA for a 4-20 mA output or -10 V for a ±10V output.
4. Set the input at maximum, and then adjust the Span pot for the exact maximum output desired. The Span control should only be adjusted when the input signal is at its maximum. This will produce the corresponding maximum output signal. Example: for 4-20 mA output, the Span control will provide adjustment for the 20 mA or high end of the signal.
5. Repeat adjustments for maximum accuracy.

Output Test Function

When the Test button is depressed it will drive the output with a known good signal that can be used as a diagnostic aid during initial start-up or troubleshooting. When released, the output will return to normal.

The Test Cal. level is factory set to approximately 50% output. Example: If you are checking a 4-20 mA current loop, when the push button is held depressed, the output from the module will be approximately 12 mA.

Operation

The APD 4130 accepts a temperature input and provides a linearized and optically isolated DC voltage or current output.

The green LoopTracker® input LED provides a visual indication that a signal is being sensed by the input circuitry of the module. It also indicates the input signal strength by changing in intensity as the process changes from minimum to maximum.

If the LED fails to illuminate, or fails to change in intensity as the process changes, check the module power or signal input wiring. Note that it may be difficult to see the LEDs under bright lighting conditions.

The red LoopTracker output LED provides a visual indication that the output signal is functioning. It becomes brighter as the input and output changes from minimum to maximum.

For a current output, the red LED will only light if the output loop current path is complete. For either current or voltage outputs, failure to illuminate or a failure to change in intensity as the process changes may indicate a problem with the module power or signal output wiring.

The yellow status LED provides a visual indication of operational modes.

- Normal operation: Off
- Push-to-Test mode: Steadily on
- Operational error: Blinking 2 digit code as listed below.

Check sensor and wiring, or consult factory.

- 1 Analog-digital converter out-of-range
- 2 Sensor under range
- 3 Sensor over range
- 4 CJC sensor abnormal range
- 5 CJC failure
- 6 Hard ADC out-of-range
- 7 Sensor hard fault
- 8 Open circuit, hard ADC fault, or hard CJC failure

Quick check: disconnect the thermocouple and install a jumper across the thermocouple input connection. If the error code goes away, check thermocouple and thermocouple wiring.

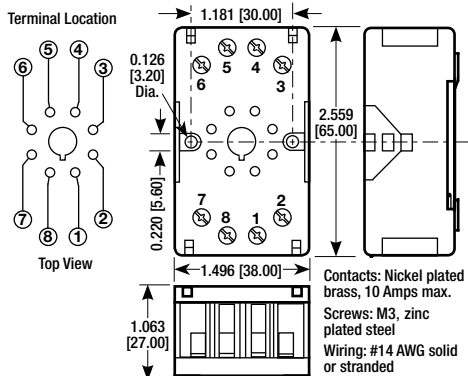

API 008 FS 8-Pin Finger Safe Socket

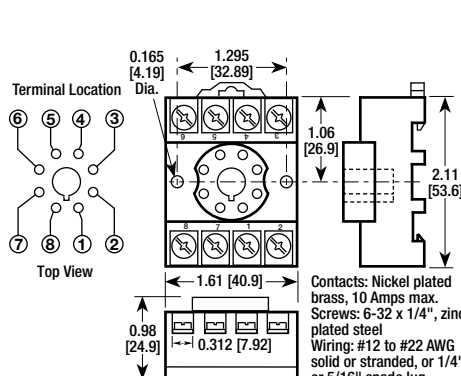

API 008 8-Pin Socket